

Specifications		CO ₂ Incubators		O ₂ /CO ₂ Incubators	
Model No.	220 V-240 V, 50 Hz (CE)	MCO-5AC-PE	MCO-18AC-PE*1	MCO-80IC-PE*1	MCO-5M-PE*1
	220 V, 60 Hz	MCO-5AC-PK	MCO-18AC-PK	MCO-80IC-PK	MCO-5M-PK
	110 V-120 V, 60 Hz	MCO-5AC-PT	MCO-18AC-PT	—	MCO-5M-PT
Exterior dimensions (W x D x H)*2	480 x 548 x 575 (mm)	620 x 710 x 900 (mm)	986 x 853 x 2040 (mm)	480 x 548 x 575 (mm)	
	18.9 x 21.6 x 22.6 (inch)	24.4 x 27.9 x 35.4 (inch)	38.8 x 33.6 x 80.3 (inch)	18.9 x 21.6 x 22.6 (inch)	
Interior dimensions (W x D x H)	350 x 378 x 375 (mm)	490 x 523 x 665 (mm)	806 x 693 x 1524 (mm)	350 x 378 x 375 (mm)	
	13.8 x 14.9 x 14.8 (inch)	19.3 x 20.6 x 26.2 (inch)	31.7 x 27.3 x 60.0 (inch)	13.8 x 14.9 x 14.8 (inch)	
Interior volume	49 liters / 1.7 cu.ft.	170 liters / 6.0 cu.ft.	851 liters / 30.1 cu.ft.	49 liters / 1.7 cu.ft.	
Net weight	49 kg / 108 lbs.	92 kg / 203 lbs.	275 kg / 606 lbs.	50 kg / 110 lbs.	
Temperature	Heating method	Direct Heat & Air Jacket (DHA)		Heater with fan air circulation, Cross shelf laminar air flow	Direct Heat & Air Jacket (DHA)
	Temp. control system	Microprocessor PID			
	Temp. range	5°C above ambient temperature to +50°C (Ambient temperature: 5°C to 35°C)			
	Temp. uniformity	±0.25°C*		±0.5°C*	±0.25°C*
CO ₂	Temp. controllability	±0.1°C*			
	CO ₂ control system	On-Off control		Microprocessor PID	
	CO ₂ sensor	Thermal conductivity		Infrared	Thermal conductivity
	CO ₂ range	0 % to 20 %			
CO ₂ controllability	±0.15 %*				
O ₂	O ₂ control system	—	—	—	Microprocessor PID
	O ₂ sensor	—	—	—	Zirconia
	O ₂ range	—	—	—	1 % to 18 %, 22 % to 80 %
	O ₂ controllability	—	—	—	±0.2 %*
Humidity	Humidifying system	Natural vaporization with water in humidity pan		*Normal mode: Natural evaporation with humidifying water High humidity mode: heated evaporation with humidifying water	Natural vaporization with water in humidity pan
	Chamber humidity	95 ±5 % RH		Normal mode: Over 80 % RH High humidity mode: Over 90 % RH	95 ±5 % RH
Shelves	Shelf dimensions (W x D x H)	310 x 310 x 12 (mm) 12.2 x 12.2 x 0.5 (inch)	450 x 450 x 12 (mm) 17.7 x 17.7 x 0.5 (inch)	776 x 659 x 10 (mm) 30.6 x 25.9 x 0.4 (inch)	310 x 310 x 12 (mm) 12.2 x 12.2 x 0.5 (inch)
	Shelf material	Copper-enriched stainless steel		Copper alloy stainless steel	Copper-enriched stainless steel
	Maximum load	4 kg / 8.8 lbs. per shelf	7 kg / 15.4 lbs. per shelf	30 kg / 66.1 lbs. per shelf	4 kg / 8.8 lbs. per shelf
	Shelves	3 Standard, 6 Max.		3 Standard, 15 Max.	5 (standard)
Contamination control	Interior surface	Copper-enriched Stainless Steel		Copper-enriched stainless steel (except humidifying pan)	Copper-enriched Stainless Steel
	UV lamp (ozone-free)	Option			
Water level sensor	Optical type		Thermal type	Optical type	
Access port	30 mm [1.2"] diameter		40 mm [1.6"] diameter, Two locations, each on both sides	30 mm [1.2"] diameter	
Air filter	0.3 µm, Efficiency: 99.97 % (for CO ₂)			0.3 µm, Efficiency: 99.97 % (for CO ₂ /N ₂ /O ₂)	
Alarm system	<ul style="list-style-type: none"> High/low temperature CO₂ density Door ajar UV lamp failure Water level Independent overheat protection 		<ul style="list-style-type: none"> High/low temperature CO₂ density Door ajar Water level Independent overheat protection 	<ul style="list-style-type: none"> High/low temperature CO₂/O₂ density Door ajar UV lamp failure Water level Independent overheat protection 	
Remote alarm contacts	30 V DC, 2 A allowable				

Optional Accessories

Stacking Kits

Lower unit	Upper unit	
	MCO-18AC	MCO-5AC / MCO-5M
MCO-18AC	[Standard]*	—
MCO-5AC / MCO-5M	—	[Standard]

* 0.5 kit is included and fixed under rear cover of MCO-18AC.

* Conditions

Ambient temperature: 25°C, Temperature setting: 37°C, CO₂ level setting: 5%, no load
Caution: For using the equipment at altitudes higher than 1,000m, the standard outer glass door must be replaced with a specific glass door. Please consult your PHCbi sales representative or agent for more information and to arrange airfreighting if required. Use of equipment in the chamber will require AC power from an external outlet. PHC Corporation guarantees the product under certain warranty conditions. PHC Corporation is in no way shall be responsible for any loss of content or damage to content.

• Appearance and specifications are subject to change without notice.

*1 Without Saudi Arabia

*2 Exterior dimensions of main cabinet only. See dimension drawings showing handles and other external projections.



Preservation (freezers, refrigerators) and Culturing (incubators) Equipment

The management of the design, development, production, sales support, and servicing of the above.

PHC Corporation, Biomedical Division

1-1-1 Sakada, Oizumi-machi, Ora-gun, Gunma, 370-0596, Japan



PHC Corporation, Biomedical Division is certified for:
Environmental management system: ISO14001

DISTRIBUTED BY:

PHCbi
 PHC Corporation

<https://www.phcd.com/global/biomedical/>

Printed in Japan 3001-2018-04-BA

PHCbi

Professional CO₂ and O₂/CO₂ Incubators



Incubation

CO₂ and O₂/CO₂ Incubators

Providing an ideally controlled environment for various cell cultures



Life Science Innovator Since 1966

PHC Corporation, Biomedical Division

Preventive Contamination Control & Decontamination System

Contamination is the worst enemy of cell culture. PHCbi's solution to the problem is Preventive Contamination Control powered by Exclusive inCu-saFe copper-alloyed stainless steel interior and patented SafeCell UV sterilization system that significantly reduce the risk of contamination while cell culture protocols are in process.

inCu-saFe
inCu-saFe copper-enriched stainless steel is PHCbi proprietary solution against contamination that combines the bacteria-killing property of copper with the corrosion resistance of stainless steel.

Copper-enriched Stainless Steel Kills Mycoplasma

PHCbi is proud to announce that inCu-saFe, the copper-enriched stainless steel used in the interior of its CO₂ and O₂/CO₂ incubators, kills mycoplasma. Mycoplasma is one of the most common causes of contamination found in cell culture and the source can often be traced back to contaminated laboratory apparatus. The inCu-saFe walls and shelves inside PHCbi CO₂ and O₂/CO₂ incubators eliminate mycoplasma and significantly reduce the risk of contamination without emptying the incubator.

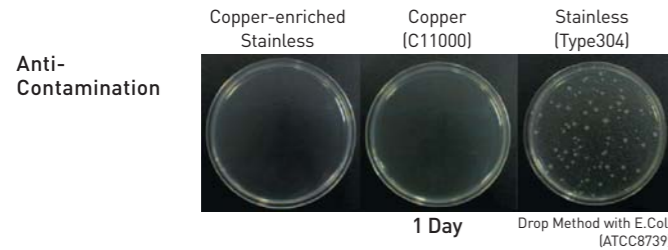

Bacteria killing rate after 24 hrs* (Drop Method)

Species	Stainless (Type304)	Copper Alloy Stainless
Escherichia coli (ATCC8739)	0 %	99.928 %
Escherichia coli (IF03301)	0 %	99.847 %
Staphylococcus aureus (ATCC6538P)	0 %	99.998 %
Bacillus subtilis (ATCC6633)	0 %	99.997 %

(N=3) *Bacteria killing rate=[1-Test Sample Colony No./Control Colony No.] x 100

SafeCell UV
SafeCell UV system with programmable ultraviolet lamp, isolated from cell cultures, sterilizes chamber air and water in the humidifying pan to maintain contamination-free conditions within the chamber.

Completely Safe for Cell Culture

- Ozone-free UV lamp
- UV shielded from culture area by the tray cover of humidifying pan.
- UV shielding by laboratory dishes and flaskets (Laboratory dishes and flaskets are made of polystyrol with thickness of 50 mm, shielding UV 100 %). [Photos below show the lid of the laboratory dish shielding UV without preventing proliferation of culture.]

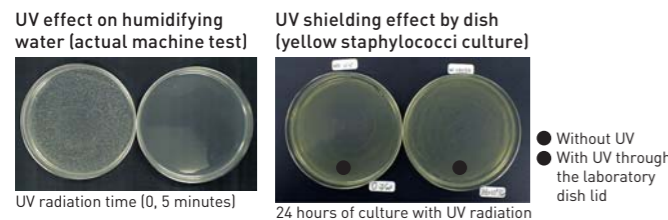

UV effect on circulating air in chamber

Time	Colony number
30 minutes after door opening (without UV)	11
2 minutes after UV radiation	0
5 minutes after UV radiation	0

*Bacteria not detected after 2 minutes of UV radiation.

Environmental Improvement with High Precision

Improved Temperature Stability with D.H.A. System

(Except MCO-801C)
The patented Direct Heat and Air Jacket conditioning system precisely regulates temperature through three independent heating zones under microprocessor PID control. Uniform temperatures are further enhanced by gentle fan circulation.

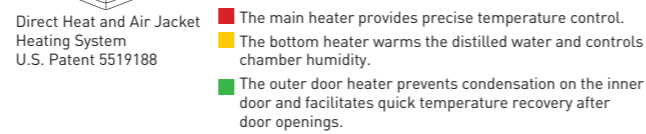

Easy Maintenance

Auto Calibration (MCO-18AC)

The microprocessor will automatically "Zero" the incubator using room air as a reference. This feature will maintain an accurate CO₂ control without worrying about CO₂ drift.

Automatic Setup

By turning on the power and simply entering the temperature and CO₂ setpoints into the unit you can walk away while the microprocessor takes over. The unit will attain setpoint and adjust itself to your required parameters.

Rounded Corners

The interior chamber is constructed of Copper Alloy stainless steel with rounded corners. All plenums, shelves, brackets and standard humidity pan are removable without the use of tools. These design features provide an interior that is easily cleaned to reduce chances of contamination.

For Superior Usability

Shelves Provide Easier Access to Culture Containers (MCO-18AC)

Much more convenience has been obtained by slanting downward the bending direction of the front of the shelves. As a result, putting in and taking out culture containers like dishes and micro plates have become extremely easy.

Water Level Sensor

The humidity pan has an optical water level sensor to warn of a low water level.

Automatic CO₂ Cylinder Switchover System (option)

This system automatically switches from the primary to secondary gas cylinder when a CO₂ gas level drop in the chamber is detected. The in-use gas cylinder is confirmed on the control panel.

Inner Door and Gasket

The inner design is critical to successful contamination control technique. The inner gasket body forms an effective thermal transition between the ambient air and warm, humidified incubator atmosphere, minimizing condensation and eliminating moisture traps which can harbor contaminants.

Stackable Design Takes Up Less Space

By simply using the fixing metal supplied as a standard accessory, two*1 or three*2 units can be stacked according to available space and usage. This configuration is also cost-effective.

*1 MCO-5AC/18AC/5M
*2 MCO-5AC/5M

CO₂ Incubator with Water Jacketed System for Stable Temperature Environment

PID control plus chamber direct sensing system maintains a high-precision temperature environment.

Through the combination of a PID (Proportional, Integrated and Differential) control system for ultra-precise temperature control and a cabinet-air sensing system which accurately monitors inside temperature, this model exhibits exceptional precision within ±0.1 degree of the preset temperature. For the temperature sensor, a durable, ultra-precise PT sensor (Pt 100W) is used.

Automatic stop mechanism for fan motor and CO₂ valve

With this mechanism, the fan motor and CO₂ valve are automatically stopped when the door is opened. This prevents air flow from the chamber and prevents air contamination due to the mixing of air.

MCO-18AC

Accurate & Reliable

- Continuous contamination control with inCu-saFe interior and SafeCell UV (option) technologies
- Direct Heat Air Jacket (DHA) heating system provides accurate temperature control.
- Double stackable
- Field-reversible door



CO₂ level: 0 — 20 %

Temperature: Ambient temperature +5°C — 50°C

Interior volume: 170 L (6.0 cu.ft.)

Dimensions [Unit : mm (inch)]

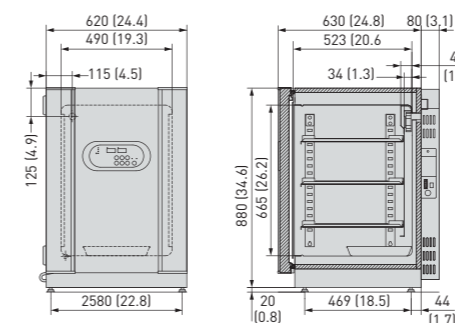

Automatic control door heater

The inside door incorporates a door heater that is interlocked with the temperature adjuster for automatic control. This prevents temperature differences between the chamber and the inner door, thereby preventing dew condensation on the inner door.

MCO-5AC

Personal type

- Continuous contamination control with inCu-saFe interior and SafeCell UV (option) technologies.
- Direct Heat Air Jacket (DHA) heating system provides accurate temperature control.
- Accurate CO₂ control & recovery characteristics
- Compact, triple stackable
- Field-reversible door



CO₂ level: 0 — 20 %

Temperature: Ambient temperature +5°C — 50°C

Interior volume: 49 L (1.7 cu.ft.)

Dimensions [Unit : mm (inch)]

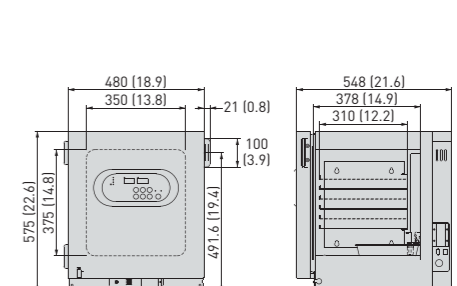

Triple-stack configuration

MCO-80IC

Reach-in design

- Continuous contamination control with inCu-saFe interior and SafeCell UV (option) technologies.
- Large capacity cabinet allows flexibility in usage.
- Full view, double paned glass door allows easy observation of cultured samples.
- Forced air surrounding chamber allows uniform temperature distribution with no temperature gradients.
- Precise CO₂ control and immediate recovery with infrared sensor.
- Unique door heater system prevents condensation.
- Cabinet can accommodate a roller bottle apparatus.



CO₂ level: **0 — 20 %**

Temperature: Ambient temperature **+5°C — 50°C**

Interior volume: **851 L (30.1 cu.ft.)**

Dimensions [Unit : mm (inch)]

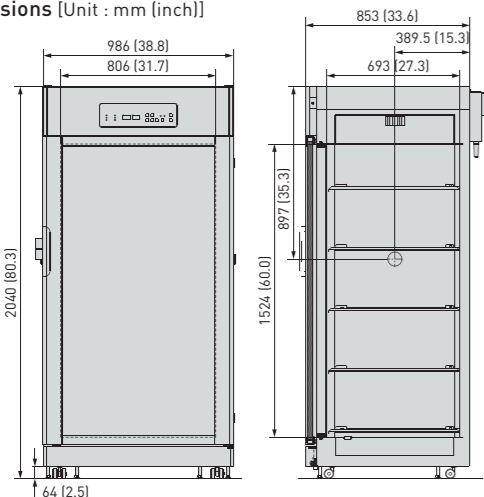

MCO-5M

Personal type

- Continuous contamination control with inCu-saFe interior and SafeCell UV (option) technologies
- Direct Heat Air Jacket (DHA) heating system provides accurate temperature control.
- Preventive contamination control
- Compact design
- Triple stackable
- Field-reversible door



CO₂ level: **0 — 20 %** O₂ level: **1 — 18 %, 22–80 %**

Temperature: Ambient temperature **+5°C — 50°C**

Interior volume: **49 L (1.7 cu.ft.)**

Dimensions [Unit : mm (inch)]

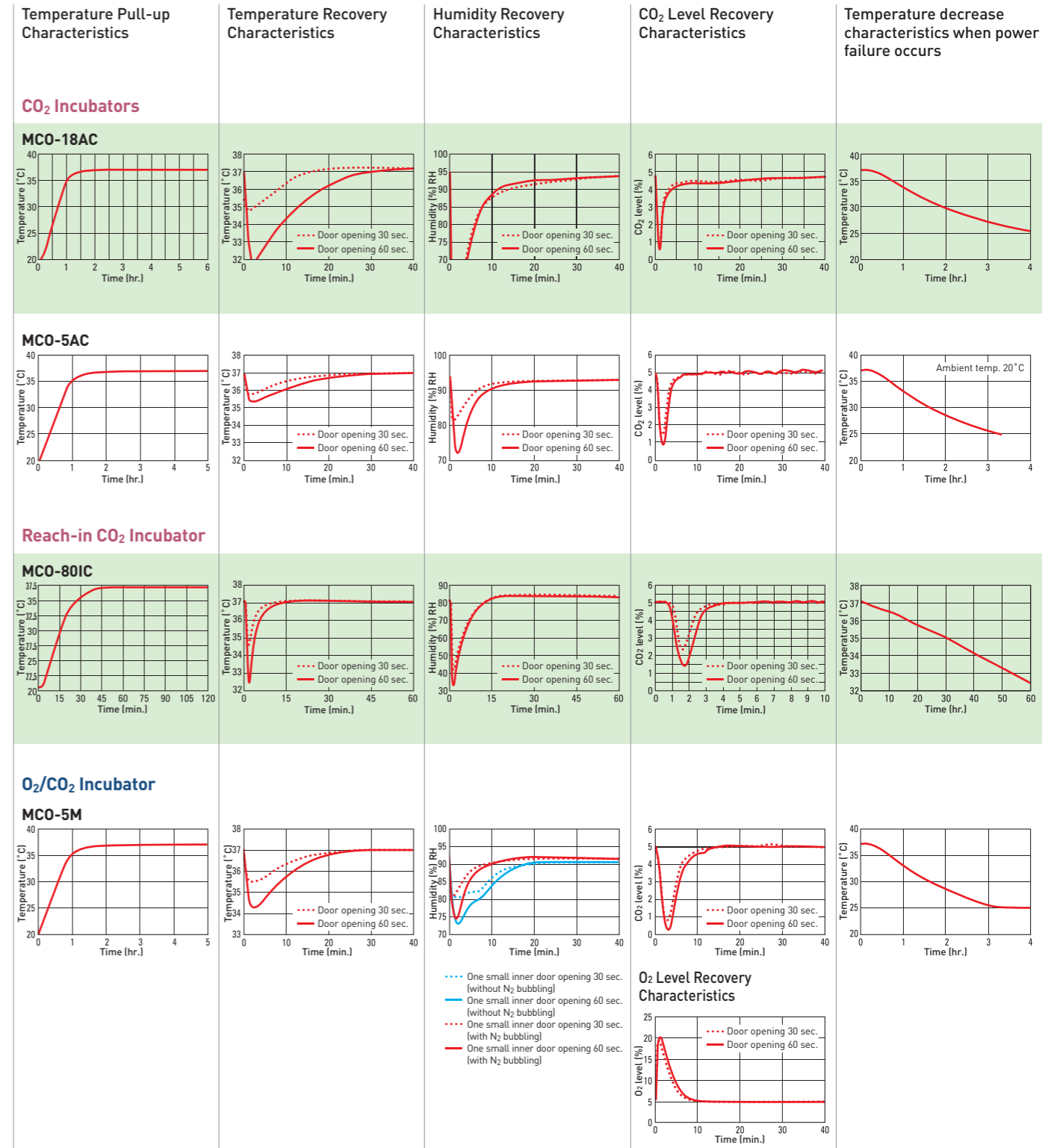
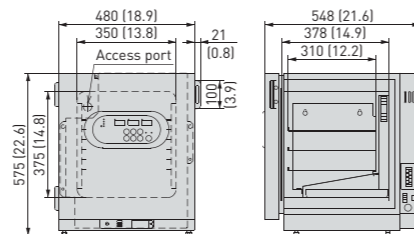

Optional Accessories

	MCO-5AC/MCO-5M	MCO-80IC	MCO-18AC
UV system set	MCO-19UVS-PE/PA/PK	MCO-80UVS-PE/PA/PK	MCO-18UVS3-PE/PA/PK
Gas regulator	MCO-010R-PW	—	MCO-010R-PW
Gas auto changer	MCO-5GC-PW	MCO-80GC-PW	MCO-21GC-PW
Tray (same as standard accessory)	MCO-30ST-PW	MCO-80ST-PW	MCO-47ST-PW
Half tray	—	—	MCO-25ST-PW
Roller base	MCO-5RB-PW	—	MCO-170RB-PW
Small door	—	MCO-80ID-PW	—
Interface board*	MTR-L03-PW or MTR-480-PW	MTR-L03-PW or MTR-480-PW	MTR-L03-PW or MTR-480-PW
Roller bottle rack mount	—	MCO-80RBS-PW	—
Auto water supply system	—	MCO-80AS-PW	—

* Only for MTR-5000 (data acquisition system) users.